

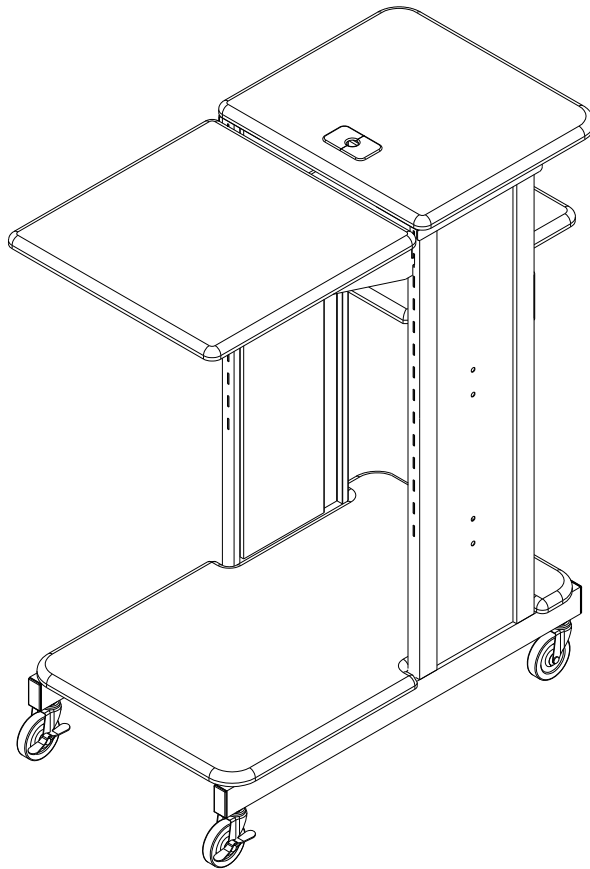

#27521 Presentation Cart











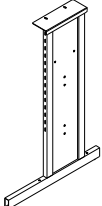
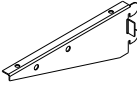
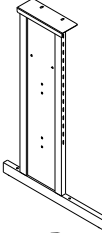
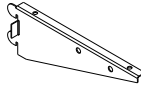
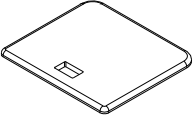
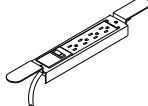
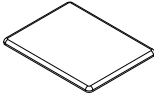
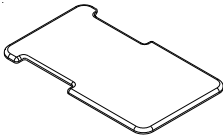

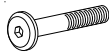

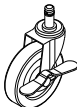

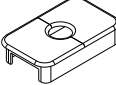



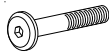

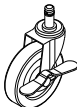

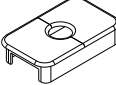
AV Cart w/ Adjustable Height Shelf

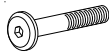

Assembly Instructions

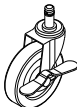
#27521 Presentation Cart

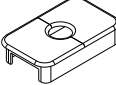
AV Cart w/Adjustable Height Shelf

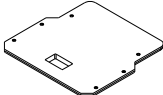
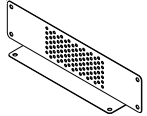
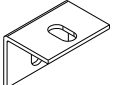
Part	Drawing	Description	Qty	Part	Drawing	Description	Qty																																
P1		Right Leg Assembly	1 EA	P-9		Right Shelf Bracket	1 EA																																
P2		Left Leg Assembly	1 EA	P-10		Left Shelf Bracket	1 EA																																
P3		LCD Platform	1 EA	<div style="border: 1px solid black; padding: 5px;">  Optional Electrical Outlet W/Cord Winder 1 EA </div>																																			
P4		Laptop Shelf	1 EA																																				
P5		Lower Shelf	1 EA	<div style="border: 1px solid black; padding: 10px;"> <h3 style="text-align: center;">Hardware List</h3> <table border="0"> <tr> <td>A</td> <td></td> <td>9/16" Socket Screw</td> <td>22 EA</td> </tr> <tr> <td>B</td> <td></td> <td>2-1/2" Socket Screw</td> <td>6 EA</td> </tr> <tr> <td>C</td> <td></td> <td>Square Nut</td> <td>4 EA</td> </tr> <tr> <td>D</td> <td></td> <td>3" Locking Caster</td> <td>2 EA</td> </tr> <tr> <td>E</td> <td></td> <td>3" Caster</td> <td>2 EA</td> </tr> <tr> <td>F</td> <td></td> <td>Plastic Grommet</td> <td>2 EA</td> </tr> <tr> <td>G</td> <td></td> <td>Allen Wrench</td> <td>1 EA</td> </tr> <tr> <td>H</td> <td></td> <td>Caster Wrench</td> <td>1 EA</td> </tr> </table> <p style="text-align: center;"><i>We recommend that you assemble this unit on a table.</i></p> <p>Tools required: Adjustable Crescent Wrench</p> </div>				A		9/16" Socket Screw	22 EA	B		2-1/2" Socket Screw	6 EA	C		Square Nut	4 EA	D		3" Locking Caster	2 EA	E		3" Caster	2 EA	F		Plastic Grommet	2 EA	G		Allen Wrench	1 EA	H		Caster Wrench	1 EA
A		9/16" Socket Screw	22 EA																																				
B		2-1/2" Socket Screw	6 EA																																				
C		Square Nut	4 EA																																				
D		3" Locking Caster	2 EA																																				
E		3" Caster	2 EA																																				
F		Plastic Grommet	2 EA																																				
G		Allen Wrench	1 EA																																				
H		Caster Wrench	1 EA																																				
P6		Middle Shelf	1 EA																																				
P7		Stability Panel	1 EA																																				
P8		Angle Bracket	4 EA																																				

Missing Parts or UPS Damaged Parts
 For Your Convenience you can
 EMAIL us at
furniture@baltinc.com
 24HOURS 7 DAYS A WEEK

Do not use unless all screws are tight. At least every six months, check all screws to be sure they are tight. If parts are missing, broken, damaged, or worn, stop use of the product until repairs are made by your dealer using factory authorized parts.

#27521 Presentation Cart Assembly Diagram



READ THROUGH INSTRUCTIONS FROM BEGINNING TO END BEFORE STARTING TO ASSEMBLE UNIT.

- 1.) Identify and Separate all the Parts and Hardware.
- 2.) Place the LCD Platform (P-3) with the insert nuts facing up. Attach 1 Right Leg Assembly (P-1) and 1 Left Leg Assembly (P-2) using 4 each (A) screws.
(Finger tighten only)

Should you require assistance during assembly, please call our Customer Service Department Monday - Friday 8 a.m. - 5 p.m. Central Standard Time 1-800-749-2258

- 3.) Attach Stability Panel (P-7) to Right & Left Leg Assemblies (P-1 & P-2) using 4 (A) Screws as shown in illustration #1.
(Finger tighten only)

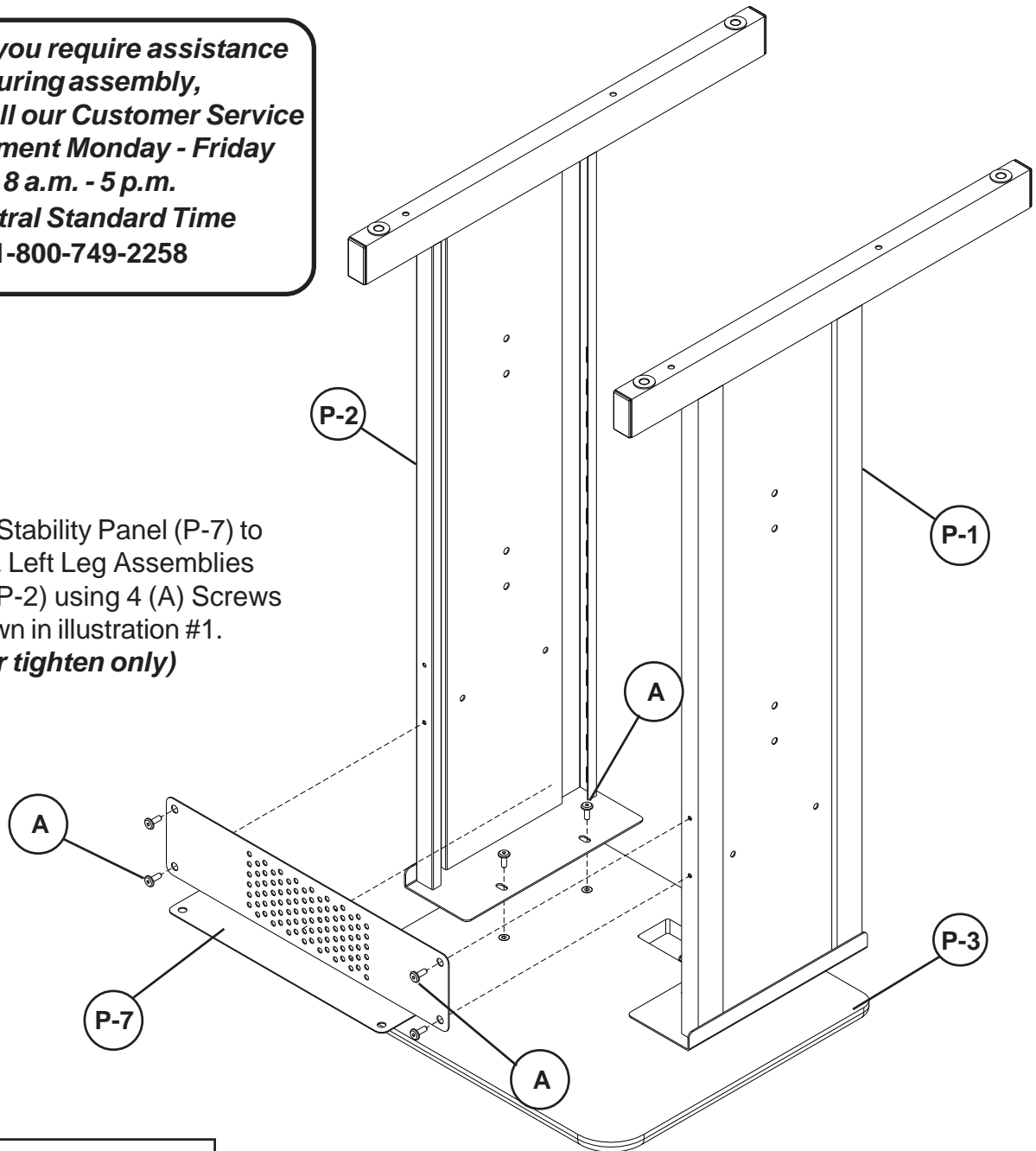
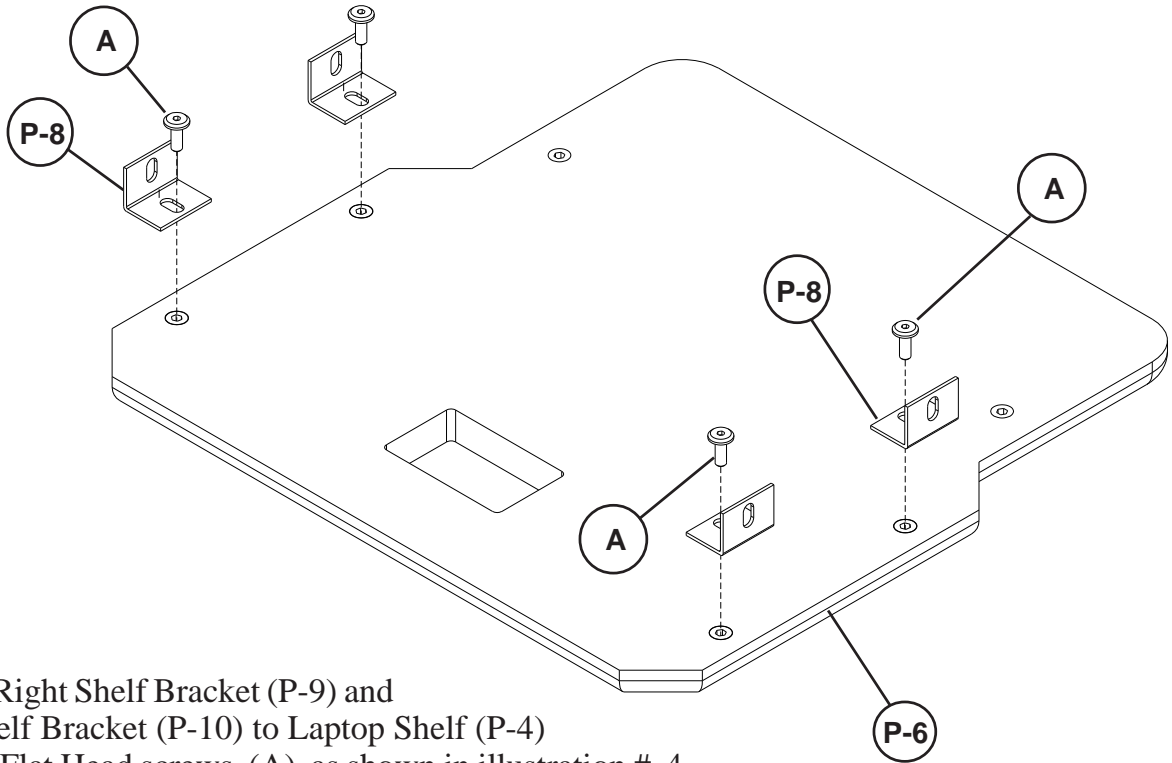

Illustration # 1

4.) Align 4 each Angle Brackets (P-8) with the edge of the Middle Shelf (P-6) and attach using 4 each (A) Screws as shown in illustration #2. (**Finger tighten only**)

Illustration # 2



5.) Attach Right Shelf Bracket (P-9) and Left Shelf Bracket (P-10) to Laptop Shelf (P-4) using 4 Flat Head screws (A) as shown in illustration # 4. (**Finger tighten only**)

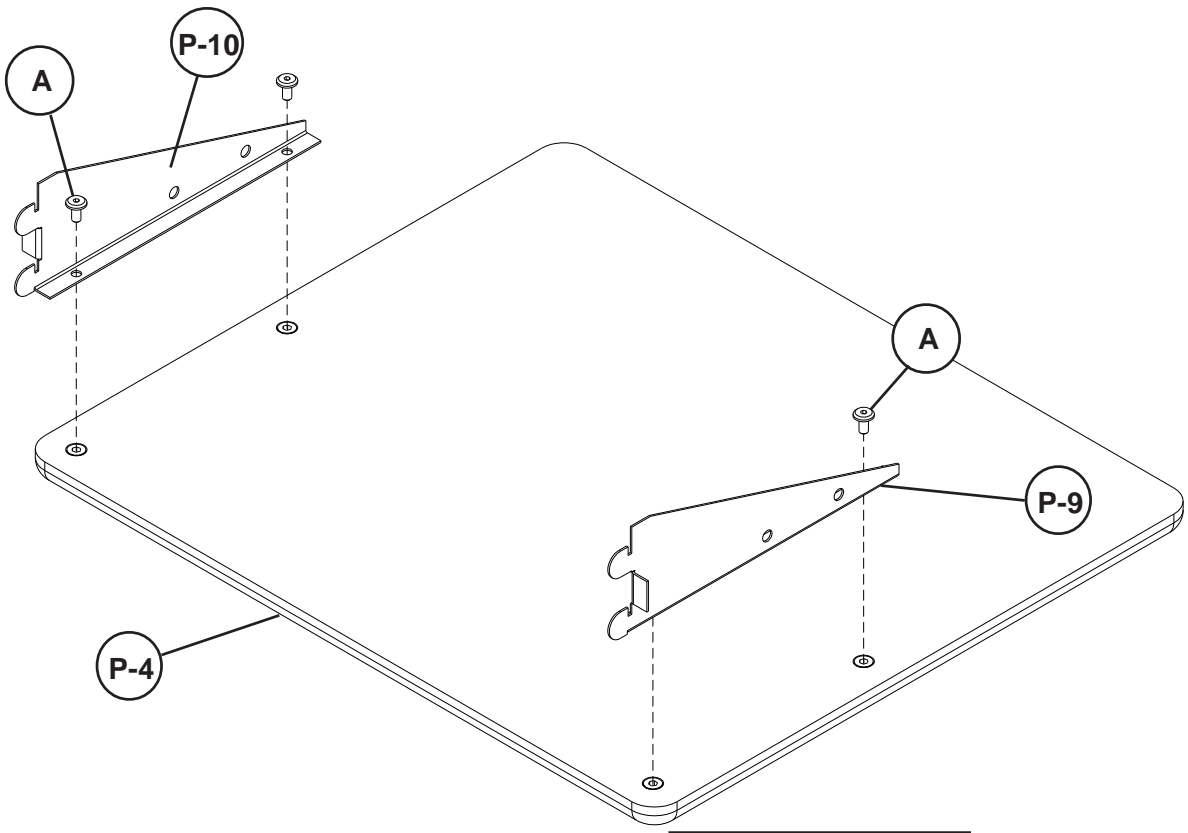
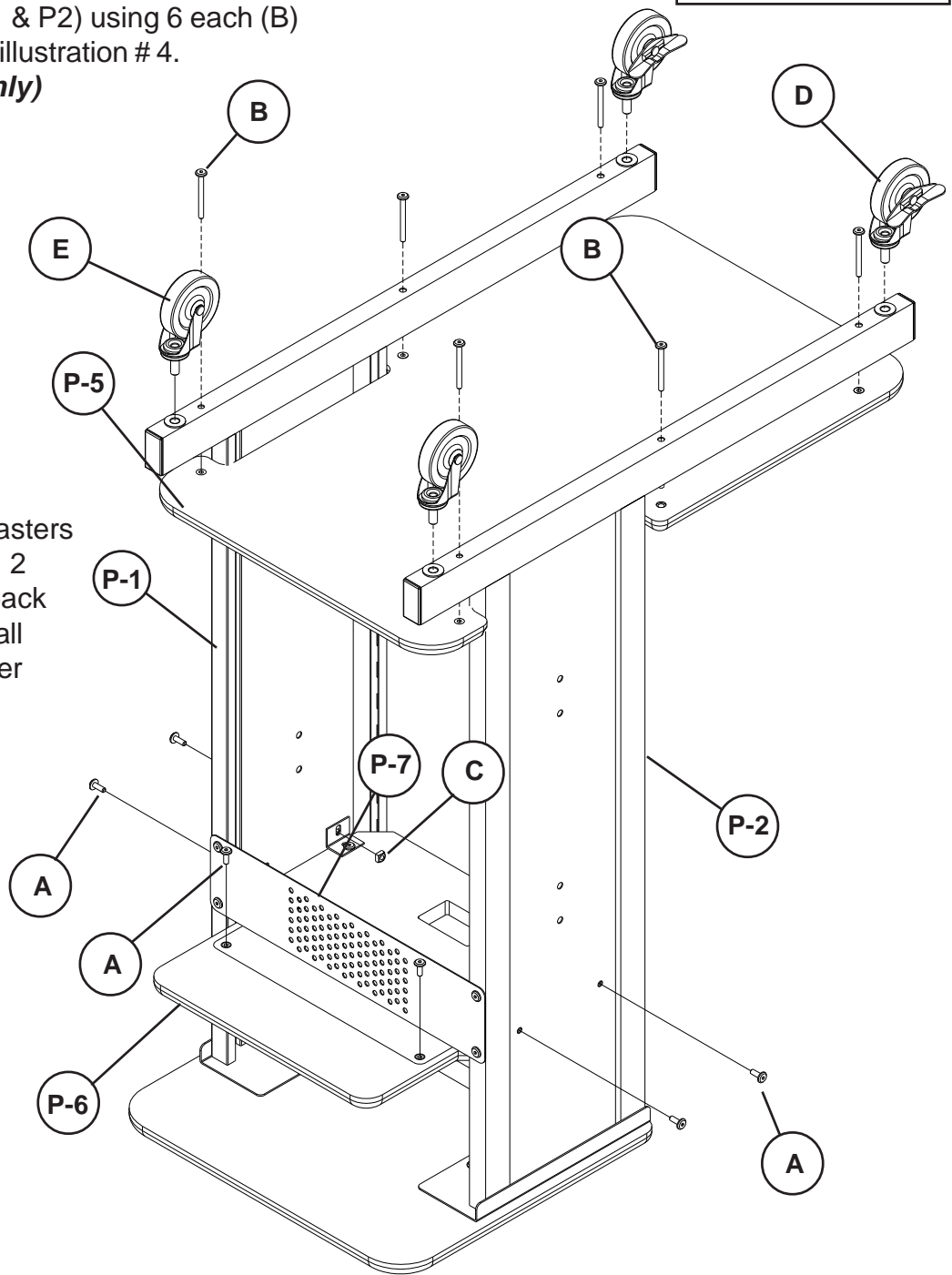

Illustration # 3

6.) Attach Lower Shelf (P-5) to the Right & Left Leg Assemblies (P1 & P2) using 6 each (B) screws as shown in illustration # 4.
(Finger tighten only)



7.) Attach 2 Locking Casters (D) to the front, and 2 Casters (E) to the back of the unit. Tighten all Casters using Caster Wrench (H).

8.) Slide Middle Shelf (P-6) Between Right & Left Leg Assemblies (P-1 & P-2) and attach Middle Shelf (P-6) using 4 each (A) screws and 4 each (C) Square Nuts as shown in illustration # 4. Secure Middle Shelf (P-6) to Stability Panel (P-7) using two screws (A).

9.) *Tighten all the screws at this time using Allen Wrench (G).*

- 10.) To install Grommets (F) in LCD Platform (P-3) and Middle Shelf (P-6), separate parts and press Grommet Sleeves in rectangular openings as shown in illustration # 5.
- 11.) Snap 2 plastic Caps over top of Sleeves as shown in illustration # 5.

**Grommet(F) installation
Illustration # 5**

- 12.) Attach Right Shelf Bracket (P-9) and Left Shelf Bracket (P-10) to the Right & Left Leg Assemblies at the desired height as shown in illustration # 5.
(Tighten 4 screws under Laptop Shelf (P-4) using Allen Wrench (G)).

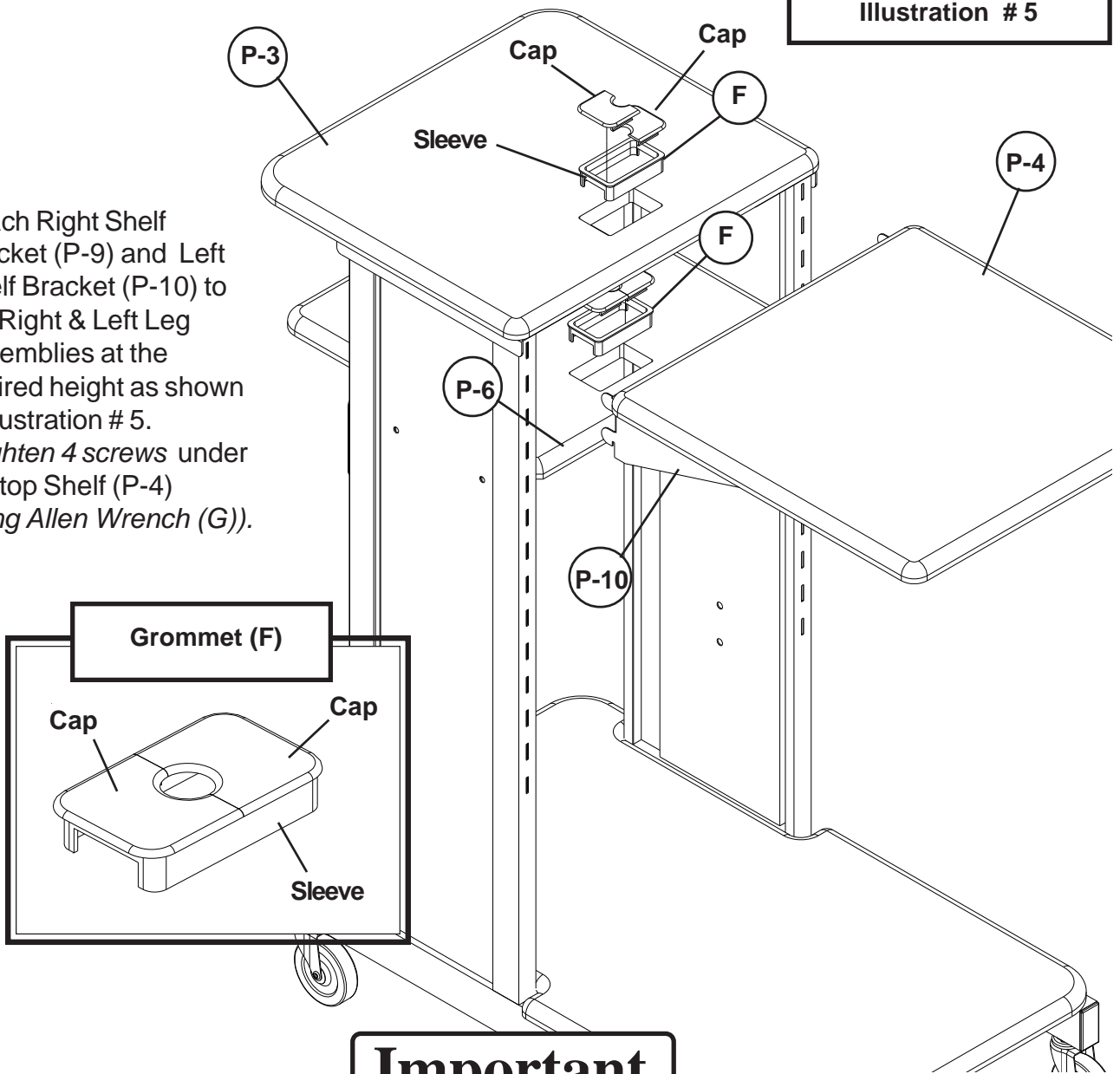

Important

The Balt product you have purchased is guaranteed against material and workmanship defects. This guarantee extends 1 year from date of purchase. Should this product fail to function satisfactorily under normal use due to defect or imperfection, the defective part or product will be replaced. Damage caused by common carriers during shipment is not included in this guarantee.

This guarantee sets forth all applicable guarantees and remedies. No other warranty, expressed or implied shall apply. Failure to follow instructions found in Important Information Section of Owner Sheet shall void the guarantee. Consequential or incidental damages and or costs are not refundable.