

BALT[®]

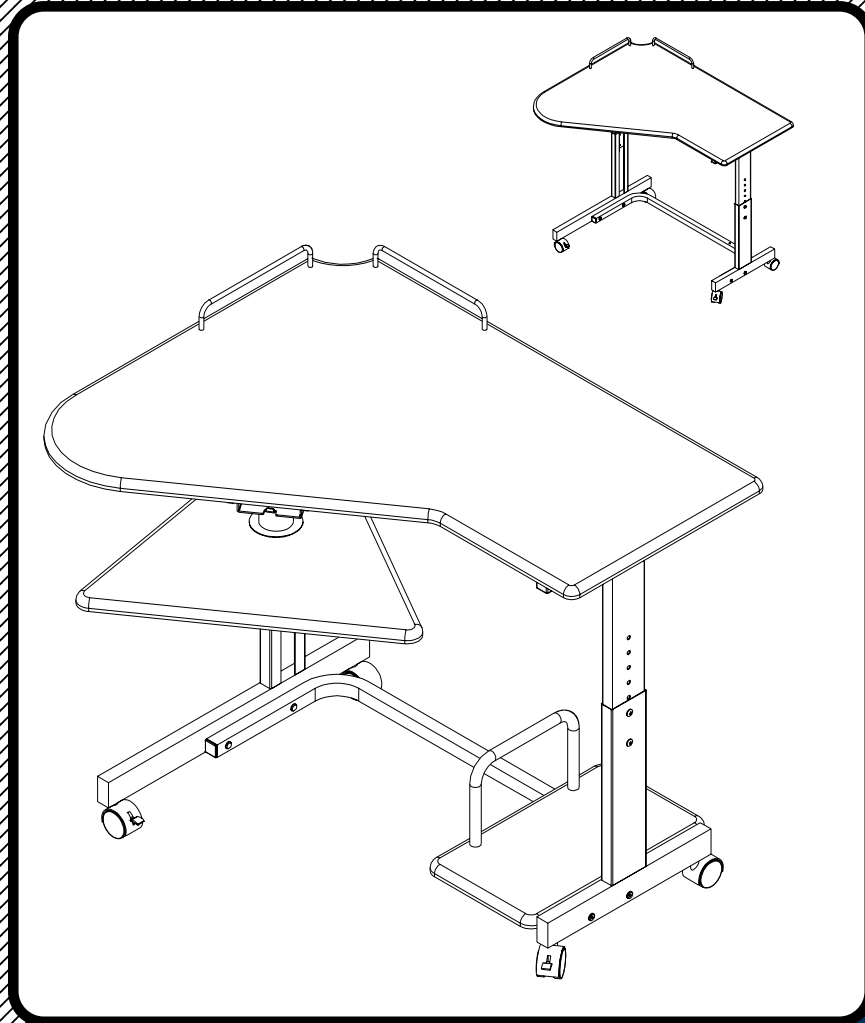









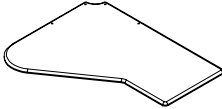
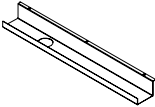
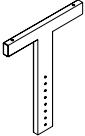
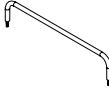
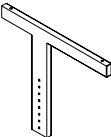

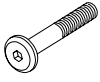







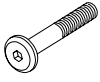



#82253 WriteAngle-RT
Workstation

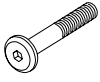

Assembly Instructions

#82253

WriteAngle-LT Workstation

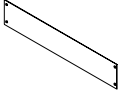
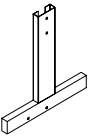
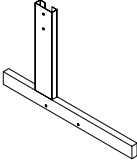
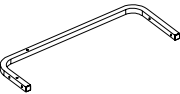
Part	Drawing	Description	Qty	Part	Drawing	Description	Qty																																				
P1		Top Panel	1 EA	P8		Cable Mgmt Tray	1 EA																																				
P2		Right Upper Insert	1 EA	P9		Security Rail	2 EA																																				
P3		Left Upper Insert	1 EA	<div style="border: 2px solid black; padding: 10px;"><h3 style="text-align: center;">Hardware List</h3><table><tbody><tr><td>A</td><td></td><td>9/16" Socket Screw</td><td>8 EA</td></tr><tr><td>A1</td><td></td><td>Wood Screw</td><td>3 EA</td></tr><tr><td>B</td><td></td><td>2-1/2" Socket Screw</td><td>8 EA</td></tr><tr><td>C</td><td></td><td>Square Nut</td><td>12 EA</td></tr><tr><td>D</td><td></td><td>2" Locking Caster</td><td>2 EA</td></tr><tr><td>E</td><td></td><td>2" Caster</td><td>2 EA</td></tr><tr><td>F</td><td></td><td>Glide</td><td>4 EA</td></tr><tr><td>G</td><td></td><td>Allen Wrench</td><td>1 EA</td></tr><tr><td>H</td><td></td><td>Caster Wrench</td><td>1 EA</td></tr></tbody></table></div>				A		9/16" Socket Screw	8 EA	A1		Wood Screw	3 EA	B		2-1/2" Socket Screw	8 EA	C		Square Nut	12 EA	D		2" Locking Caster	2 EA	E		2" Caster	2 EA	F		Glide	4 EA	G		Allen Wrench	1 EA	H		Caster Wrench	1 EA
A		9/16" Socket Screw	8 EA																																								
A1		Wood Screw	3 EA																																								
B		2-1/2" Socket Screw	8 EA																																								
C		Square Nut	12 EA																																								
D		2" Locking Caster	2 EA																																								
E		2" Caster	2 EA																																								
F		Glide	4 EA																																								
G		Allen Wrench	1 EA																																								
H		Caster Wrench	1 EA																																								
P4		Stability Panel	1 EA																																								
P5		Right Leg Receiver	1 EA																																								
P6		Left Leg Receiver	1 EA																																								
P7		Crossbrace	1 EA																																								

We recommend that you assemble this unit on a table.

Tools required: Adjustable Crescent Wrench

Missing Parts or UPS Damaged Parts

For Your Convenience you can
EMAIL us at

susanthompson@baltinc.com

24HOURS 7 DAYS A WEEK

Should you require assistance during assembly,

please call our Customer Service Department

Monday - Friday 8 a.m. - 5 p.m.

Central Standard Time 1-800-749-2258

Do not use unless all screws are tight. At least every six months, check all screws to be sure they are tight. If parts are missing, broken, damaged, or worn, stop use of the product until repairs are made by your dealer using factory authorized parts.

#82253 WriteAngle-RT Assembly Diagram



- 1.) Identify and Separate all the Parts and Hardware.
- 2.) See KB-Swivel assembly instructions to assemble optional keyboard.
- 3.) Place the Top panel (P1) with the insert nuts facing up. Attach Right Upper Insert (P2) and Left Upper Insert (P3) using 4 each (B) screws.
(Finger tighten only)

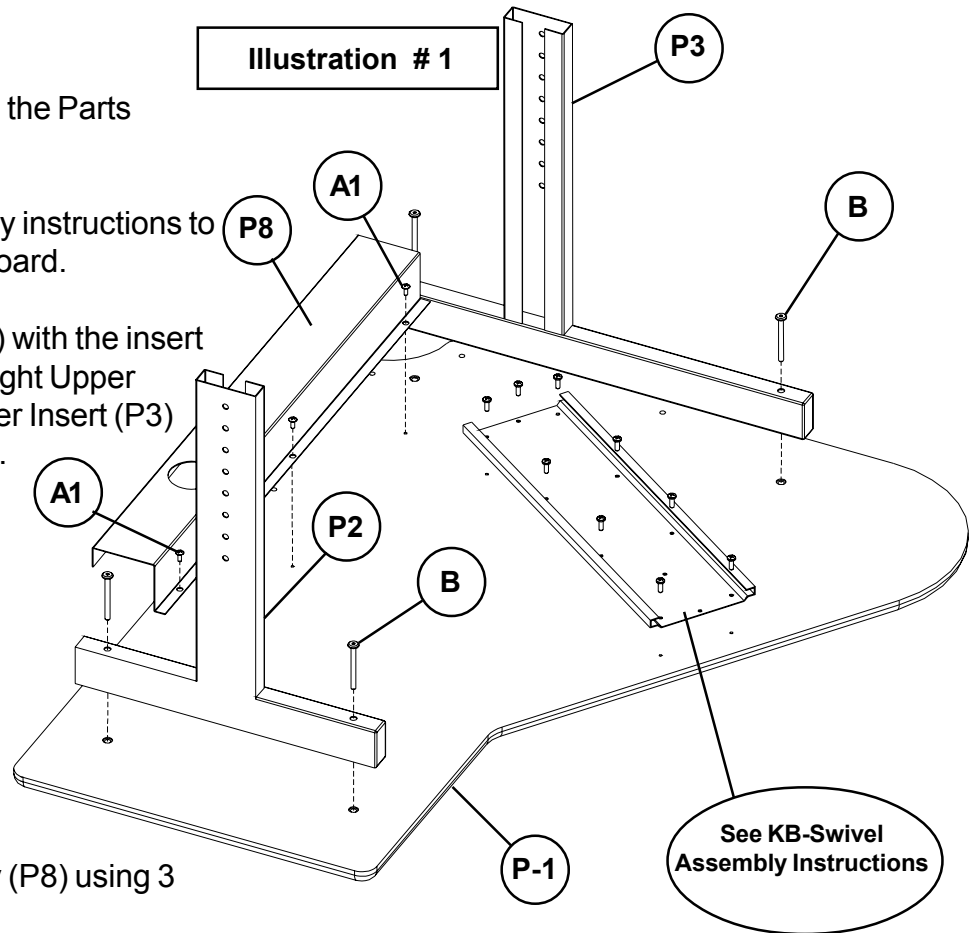

- 4.) Attach Cable Mgmt Tray (P8) using 3 each (A1) screws.

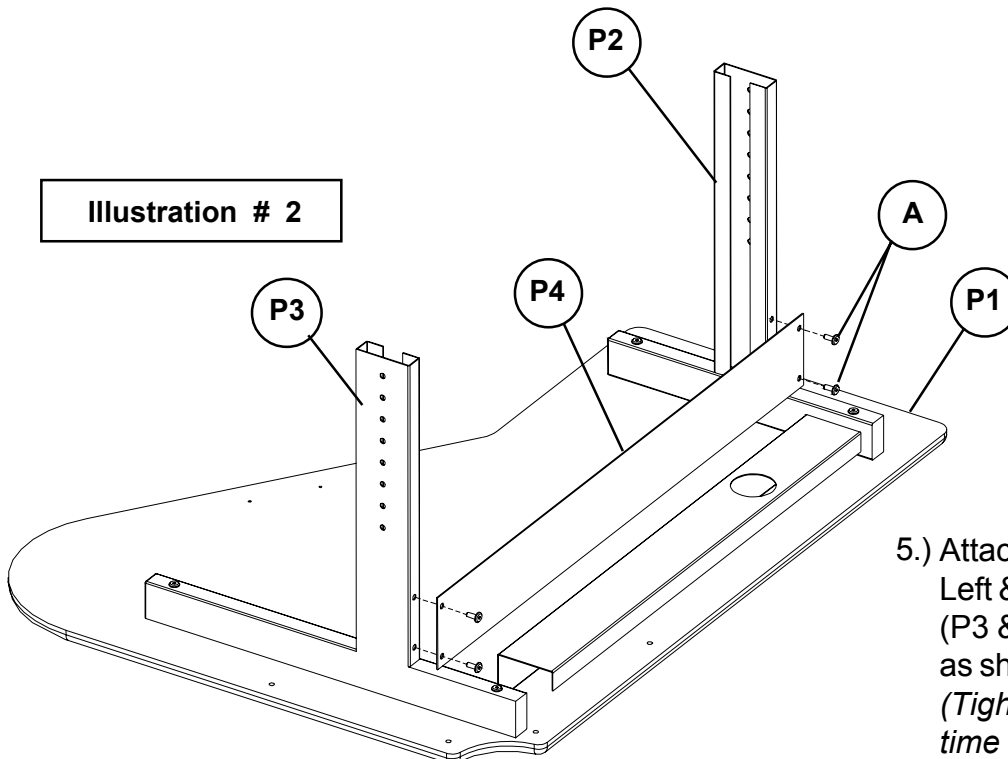

- 5.) Attach Stability Panel (P4) to Left & Right Upper Inserts (P3 & P2) using 4 Screws (A) as shown in illustration #2.
(Tighten all the screws at this time using Allen Wrench (G)).

6.) Slide Left & Right Leg Receivers (P6 & P5) over Left and Right Upper Insert (P3 & P2). Secure at desired height using 4 each (A) Screws and 4 each (C) Square nuts (flat side of the nut should be next to the metal).

7.) Attach 2 each (D) Locking Casters to the front of the 2 each Leg receivers and 2 each (E) Casters to the back of the Leg Receivers using Caster Wrench (H). (Use 4 each Leveling Glides (F) in place of Casters for stationary use.)

8.) Attach Crossbrace (P7) to Right & Left Leg Receivers (P5 & P6) using 4 Screws (A1) and 4 each Square Nuts (C) as shown in illustration #3.

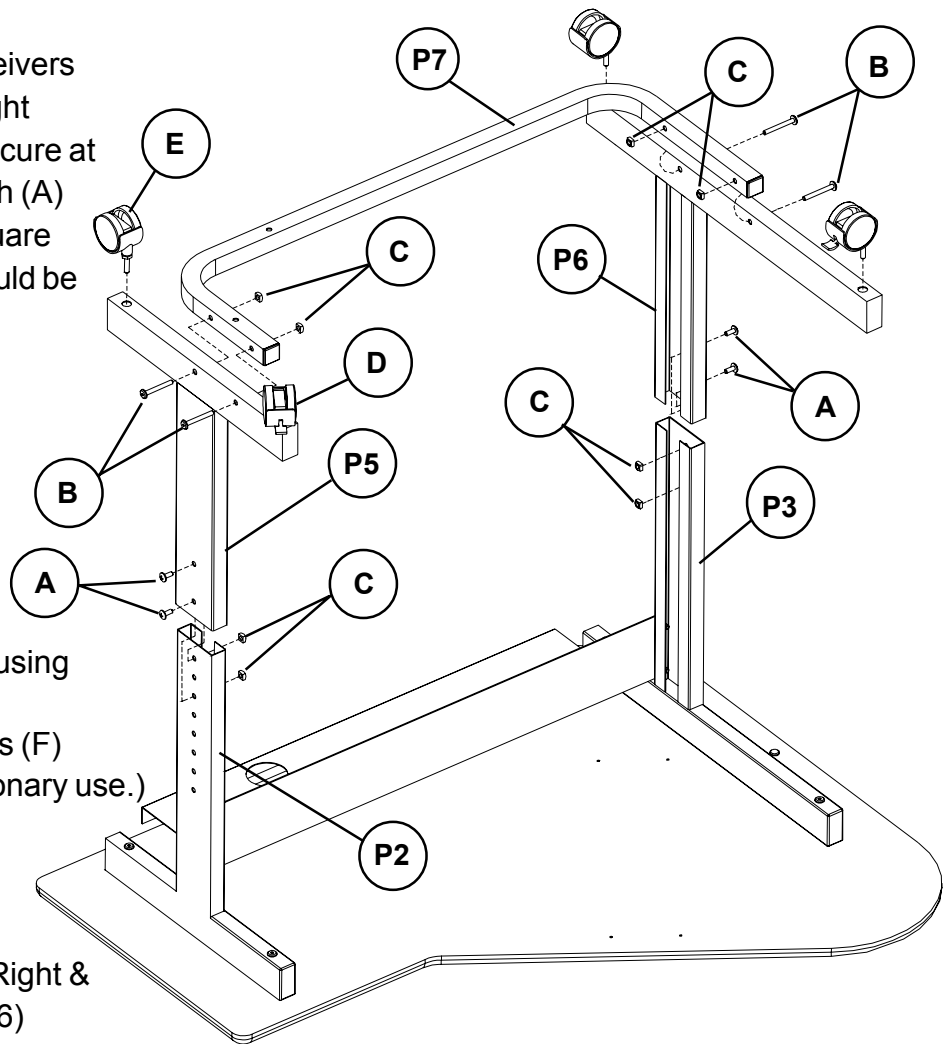
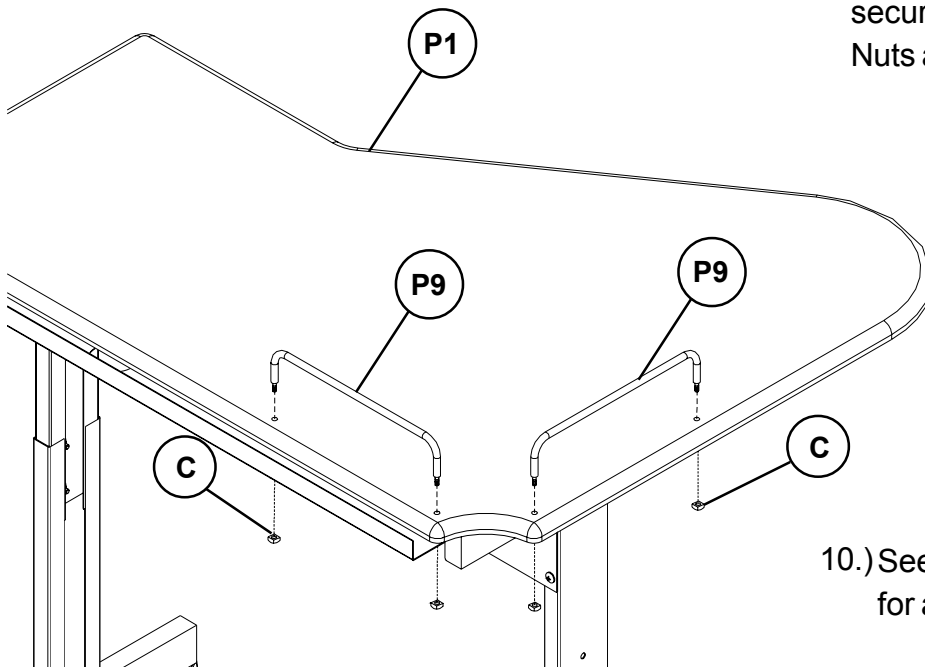

Illustration # 3

Illustration # 4

9.) Insert 2 each Security Rails (P9) through the Top Platform (P1) and secure using 4 each (C) Square Nuts as shown in illustration #4.



10.) See CPU Write Assembly Instructions for assembly of optional CPU Holder.

#82253 WriteAngle-RT Workstation



For more information
1-800-749-2258

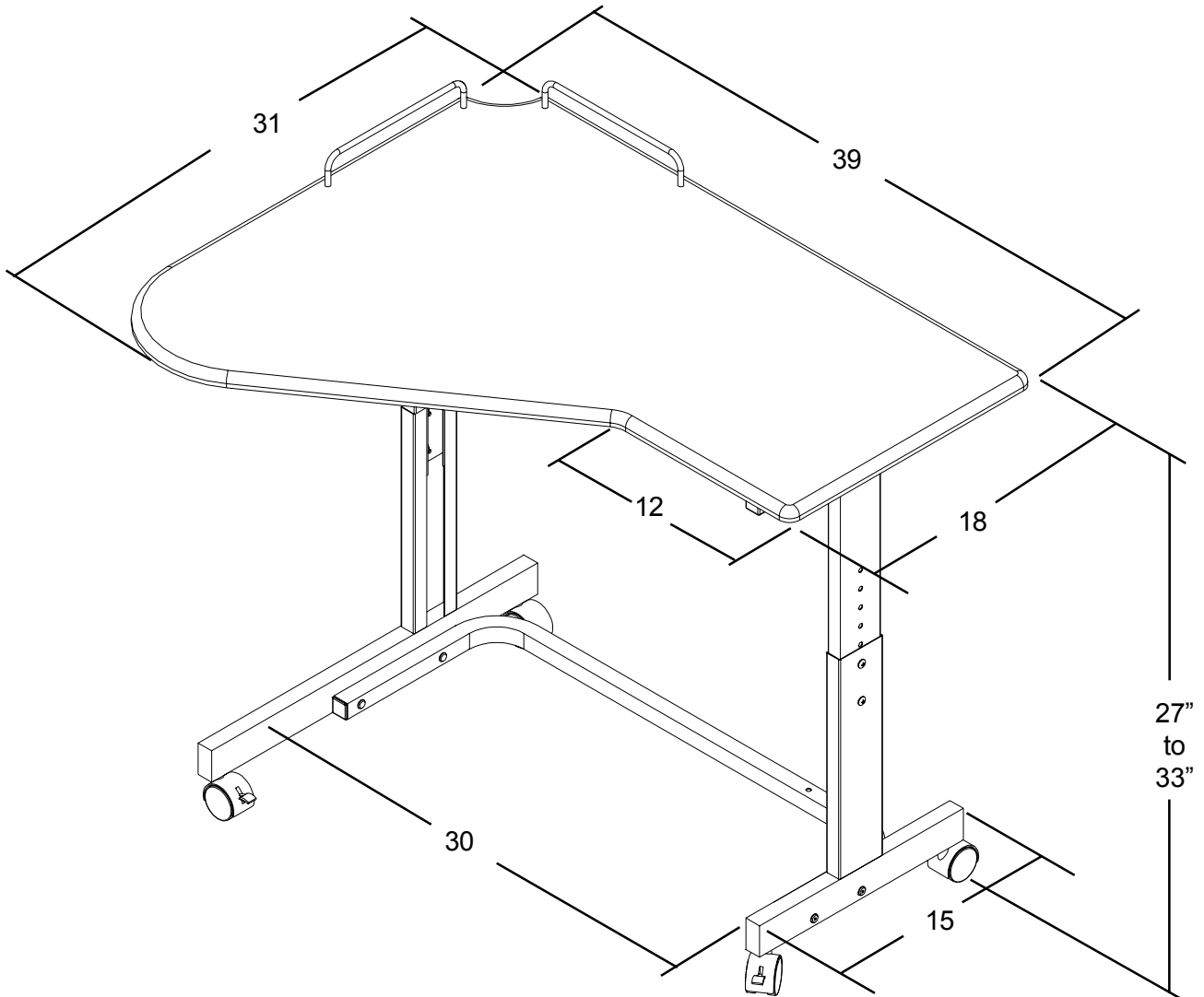

Shipping Information
3.0 Cubic Feet
39 lbs.

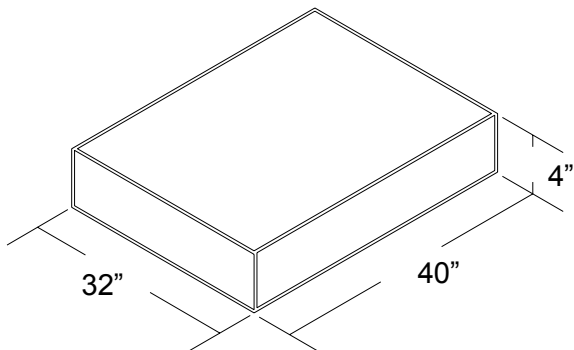

Height adjustable from 27" to 33".

Includes 2" Casters for mobility.

Available with Gray vacuum formed top and
Black Frame.

Ships UPS.